

# AcuPanel 9104/9104X

Pre-Wired Power & Energy Panel  
Meter Datasheet

ACCUEnergy



## DESCRIPTION

The AcuPanel 9104/9104X is a convenient, pre-configured meter enclosure that delivers streamlined meter deployment in OEM or retrofit projects. It is ideal for when installation inside an electrical distribution panel is unavailable, in harsh environments to safeguard instrumentation against the elements, or to limit the time and complexity of installation. Each AcuPanel undergoes rigorous quality testing to ensure years of dependable service.

## FEATURES

- + Choose from a NEMA 3 rated industrial steel enclosure or NEMA 4X rated polycarbonate enclosure suitable for both indoor and outdoor use
- + The lockable, plug-and-play housing provides protection against unwanted tampering and the elements
- + Clean, factory pre-wiring for fast, reliable installation. All necessary fuses, shorting blocks, & terminal blocks are pre-installed and labeled.
- + Self-powered panel does not require a separate power supply
- + Wires can be run through pluggable, pre-cut holes
- + Simple grounding is included inside each enclosure
- + No control transformer needed
- + Compatible with the Acuvim II Series and Acuvim L Series meters





# ACUPANEL SPECIFICATIONS

AcuPanel 9104X



AcuPanel 9104



Compatible Meters	 	 
Application	Indoor or outdoor installations that require exceptional environmental protection and weather resistance	Indoor installations that require rugged protection, but not weather resistance
Safety Certifications	UL508A, UL61010-1	UL508A, UL61010-1
NEMA Rating	NEMA 4X	NEMA 3 <sup>†</sup>
Material	Polycarbonate	Steel
Anti-Corrosive	•	
Dust Proof	•	•
Suitable for Indoor Use	•	•
Suitable for Outdoor Use	•	
Pre-Wired	•	•
Pre-Configured	•	•

<sup>†</sup> AcuPanel 9104 is NEMA 3 by default. To increase the rating to NEMA 4, add the 96-IP66 protective cover.

## EACH STANDARD, PRE-WIRED ENCLOSURE INCLUDES:

- + Terminal blocks for current transformer input
- + Shorting blocks for current transformers
- + Terminal blocks for voltage inputs
- + Three industrial-grade fuses

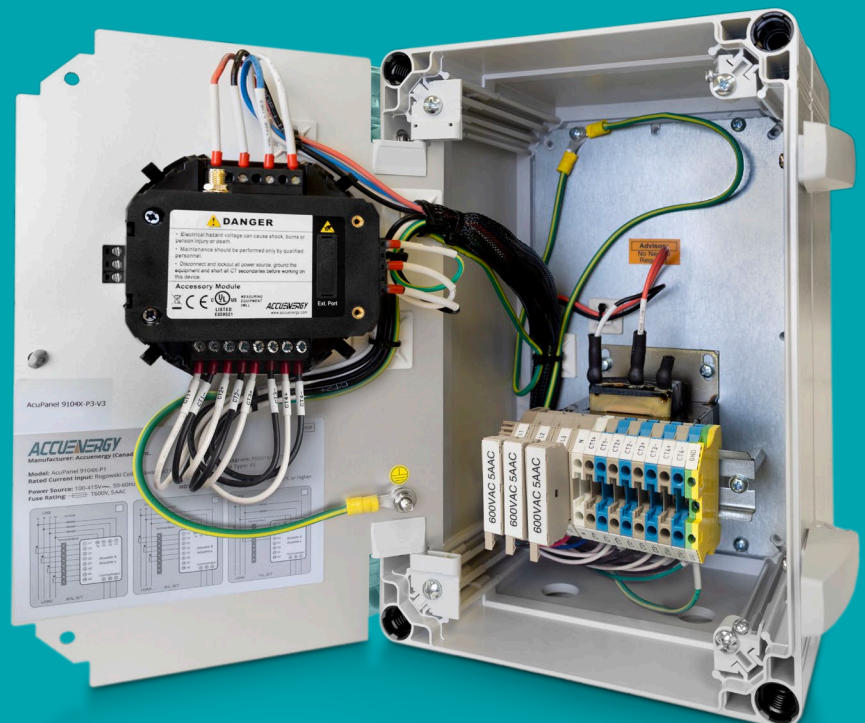

# WIRING DIAGRAMS

9104/9104X

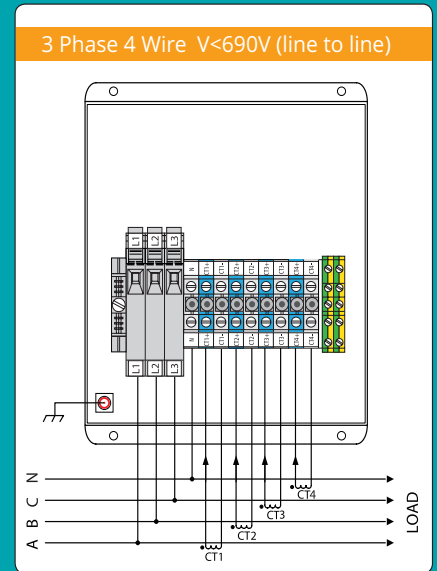
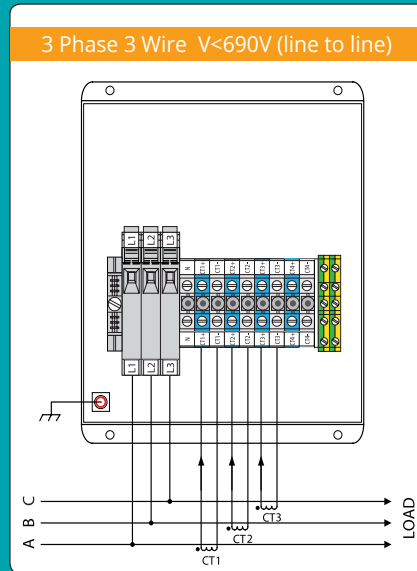
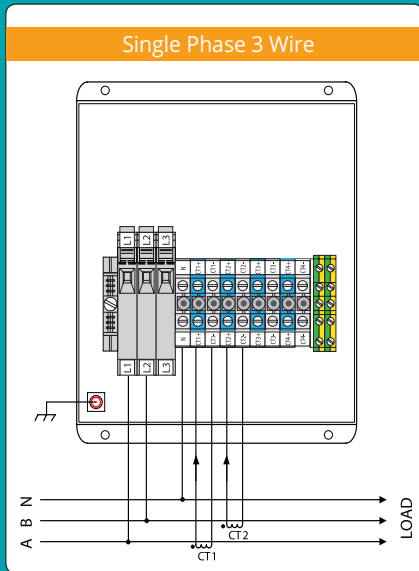

## DIMENSIONS

### AcuPanel 9104X Waterproof Polycarbonate Panel

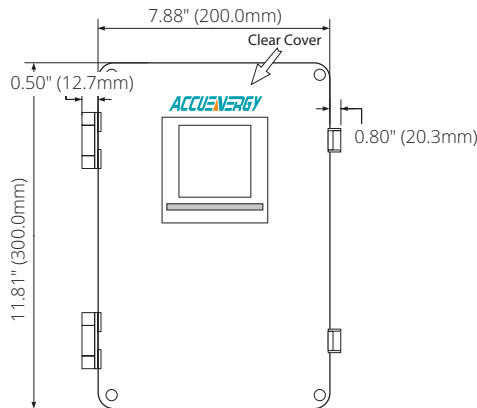

Front View

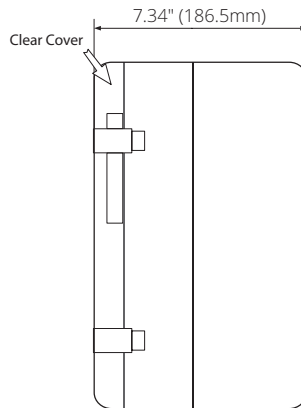

Side View

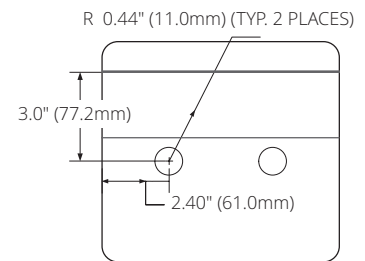

Bottom View

### AcuPanel 9104 Steel Panel

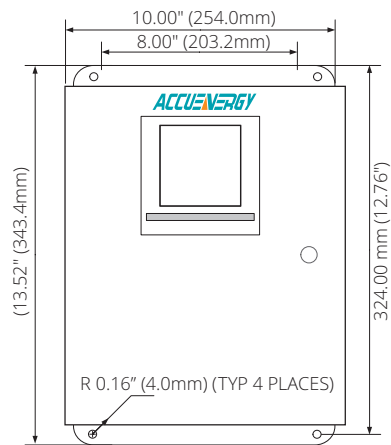

Front View

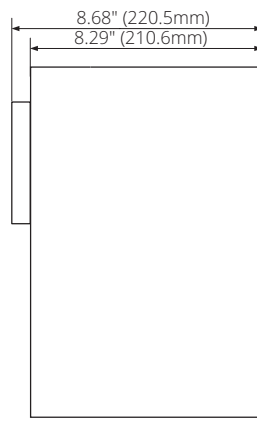

Side View

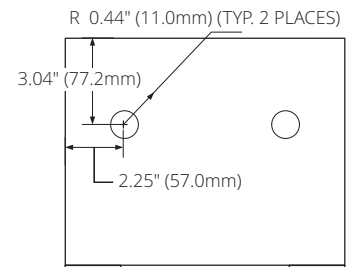

Bottom View

## CUSTOM OEM SOLUTIONS

Partner with Accuenergy to design a custom, OEM panel to suit any metering application.

- + Showcase your logo with custom branding
- + Adapt the panel to your application with specialized OEM components such as gateways, cellular modems, or power supplies
- + Suit your space or equipment needs with custom panel dimensions
- + Contact our energy metering specialists to help customize a panel solution for any unique application

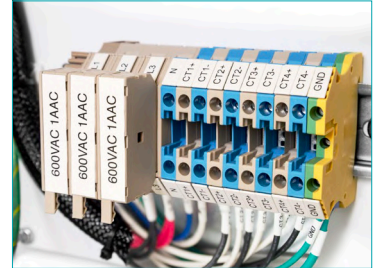
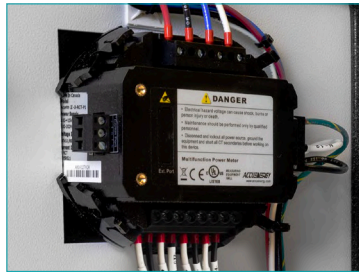

## ACCESSORIES

### Protective Display Cover

The 96-IP66 Protective Display Cover is designed for Acuvim II, Acuvim L, or other 96mm by 96mm display panel meters. Crucial in harsh environments, it increases the IP environmental rating of a meter's display to IP66 or NEMA 4X. It can be used with the AcuPanel 9104 to increase environmental rating of the enclosure from NEMA 3 to NEMA 4.



### AcuPanel 9104X Opaque Cover

The opaque cover is designed to protect the meter screen from potential damage caused by prolonged exposure to direct sunlight. By effectively shielding the screen, it helps prevent the LCD display from fading, discoloring, or deteriorating over time, ensuring that the meter maintains its visibility and functionality even in the long run.





## ORDERING INFORMATION

### Acuvim II Pre-Wired Panel

Pre-Wired Panel	Meter Model	Current Input	Power Supply	Communication Module Option*	2nd I/O Option*	3rd I/O Option*	Opaque Cover
<b>AcuPanel 9104:</b> NEMA 4 <sup>†</sup> or NEMA 3 Indoor Steel Panel	<b>IIR:</b> Acuvim II with Data Logging	<b>5A:</b> 5A or 1A (Input Field Selectable)	<b>P1V3:</b> 100~415Vac, 50/60Hz, 100-300Vdc	<b>0:</b> None	<b>0:</b> None	<b>0:</b> None	<b>OPAQUE</b>
<b>AcuPanel 9104X:</b> NEMA 4X Indoor / Outdoor Waterproof Polycarbonate Panel	<b>IIW:</b> IIR + Waveform Capture and PQ Event Logging	<b>mV:</b> 333mV Input and Rogowski Coil (Input Field Selectable)	<b>P2V3:</b> 20-60Vdc	<b>WEB2:</b> Modbus-TCP/IP, BACnet-IP, SNMP V3, DNP 3.0 V2, IEC 61850 2nd Edition, SMTP, NTP, HTTP post, HTTPS post, FTP post, sFTP server, HTTPS webserver, dual RJ45, WiFi	<b>IO1:</b> 6DI, 2RO, 1 DI Power Supply	<b>IO1:</b> 6DI, 2RO, 1 DI Power Supply	
			<b>P3V3:</b> 480Vac	<b>WEB2-D:</b> Modbus-TCP/IP, BACnet-IP, SNMP V3, DNP 3.0 V2, IEC 61850 2nd Edition, SMTP, NTP, HTTP post, HTTPS post, FTP post, sFTP server, HTTPS webserver, dual RJ45, Ethernet Port	<b>IO2:</b> 4DI, 2AO, 2DO	<b>IO2:</b> 4DI, 2AO, 2DO	
			<b>P4V3:</b> 600Vac	<b>PROFI:</b> PROFIBUS-DP	<b>IO3:</b> 4DI, 2RO, 2AI	<b>IO3:</b> 4DI, 2RO, 2AI	
				<b>RS485:</b> Second RS485 Port			
				<b>IO1:</b> 6DI, 2RO, 1 DI Power Supply			
				<b>IO2:</b> 4DI, 2AO, 2DO			
				<b>IO3:</b> 4DI, 2RO, 2AI			

Ordering Example: **AcuPanel 9104X-IIR-5A-P1V3-WEB2-IO1-IO3**  
**AcuPanel 9104X-IIR-MV-P1V3-WEB2-OPAQUE**

### Acuvim L Pre-Wired Panel

Pre-Wired Panel	Meter Model	Current Input	Power Supply	Communication Module Option*	2nd I/O Option*	3rd I/O Option*	Opaque Cover
<b>AcuPanel 9104:</b> NEMA 4 <sup>†</sup> or NEMA 3 Indoor Steel Panel	<b>CL:</b> General Meter	<b>5A:</b> 5A or 1A Nominal Current Input	<b>P1V4:</b> 100-415Vac, 50-60Hz, 100-300Vdc	<b>0:</b> None	<b>0:</b> None	<b>0:</b> None	<b>OPAQUE</b>
<b>AcuPanel 9104X:</b> NEMA 4X Indoor / Outdoor Waterproof Polycarbonate Panel	<b>EL:</b> CL + TOU and PQ parameters	<b>mV:</b> 333mV Input and Rogowski Coil (Input Field Selectable)	<b>P2V4:</b> 20-60Vdc	<b>WEB2:</b> Modbus-TCP/IP, BACnet-IP, SNMP V3, DNP 3.0 V2, IEC 61850 2nd Edition, SMTP, NTP, HTTP post, HTTPS post, FTP post, sFTP server, HTTPS webserver, dual RJ45, WiFi, Dual Ethernet Port	<b>IO1:</b> 6DI, 2RO, 1 DI Power Supply	<b>IO1:</b> 6DI, 2RO, 1 DI Power Supply	
			<b>P3V4:</b> 480Vac	<b>WEB2-D:</b> Modbus-TCP/IP, BACnet-IP, SNMP V3, DNP 3.0 V2, IEC 61850 2nd Edition, SMTP, NTP, HTTP post, HTTPS post, FTP post, sFTP server, HTTPS webserver, dual RJ45, Ethernet Port	<b>IO2:</b> 4DI, 2AO, 2DO	<b>IO2:</b> 4DI, 2AO, 2DO	
			<b>P4V4:</b> 600Vac	<b>PROFI:</b> PROFIBUS-DP	<b>IO3:</b> 4DI, 2RO, 2AI	<b>IO3:</b> 4DI, 2RO, 2AI	
				<b>RS485:</b> Second RS485 Port			
				<b>IO1:</b> 6DI, 2RO, 1 DI Power Supply			
				<b>IO2:</b> 4DI, 2AO, 2DO			
				<b>IO3:</b> 4DI, 2RO, 2AI			

Ordering Example: **AcuPanel 9104X-EL-5A-P1V4-WEB2-IO1-IO3**  
**AcuPanel 9104X-CL-MV-P2V4-WEB2-OPAQUE**

\*No more than 2 of the same I/O modules may be attached to the meter (example: Two AXM-IO2). The same two I/O modules must be a different component number.  
<sup>†</sup> AcuPanel 9104 is NEMA 3 by default. To increase the rating to NEMA 4, add the 96-IP66 protective cover.



#### Accuenergy Inc.

Los Angeles - Toronto - Pretoria  
 North America Toll Free: 1-877-721-8908  
 Web: [www.accuenergy.com](http://www.accuenergy.com)  
 Email: [marketing@accuenergy.com](mailto:marketing@accuenergy.com)



ISO 9001, 14001  
& 45001 Certified

Revision Date: November 2024 Version: 1.0.4  
 Specs Subject To Change Without Notice.